

# MDS

[mds-int.net](http://www.mds-int.net)

## M515 TRACK TROMMEL

<http://www.mds-int.net>



**MDS-INT**  
Drummond  
Carrickmacross  
Co. Monaghan, IRELAND

**TEL: +353 42 966 7899**  
**EMAIL: [info@mds-int.net](mailto:info@mds-int.net)**  
**WEB: [www.mds-int.net](http://www.mds-int.net)**

The M515 Track Trommel is perfect for cleaning dirty material and can handle rocks up to 800 mm (32") in size. It comes complete with fold out stockpiling conveyors and is ideal for moving around the quarry and from one site to the next.

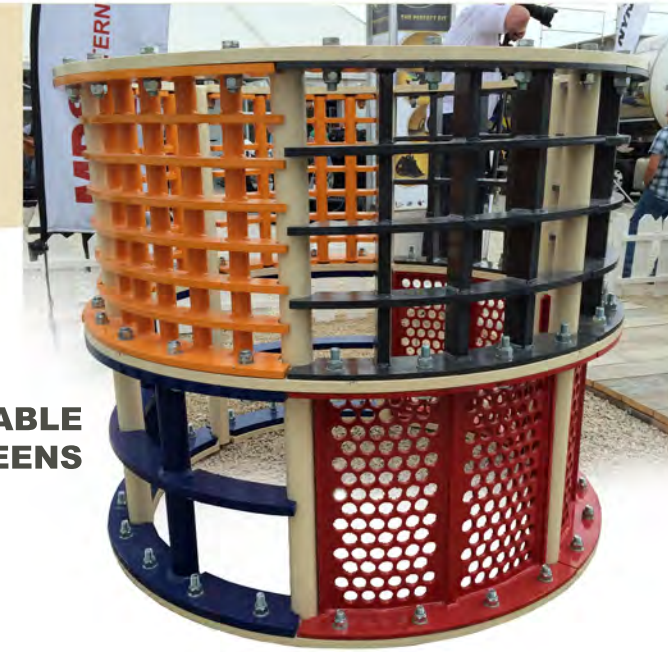

**CHANGEABLE SCREENS**

**TECHNICAL SPECIFICATIONS**

**TRANSPORT DIMENSIONS**

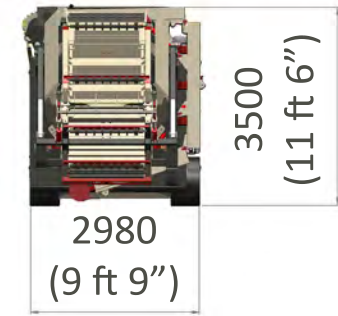

16203 (53 ft 2")

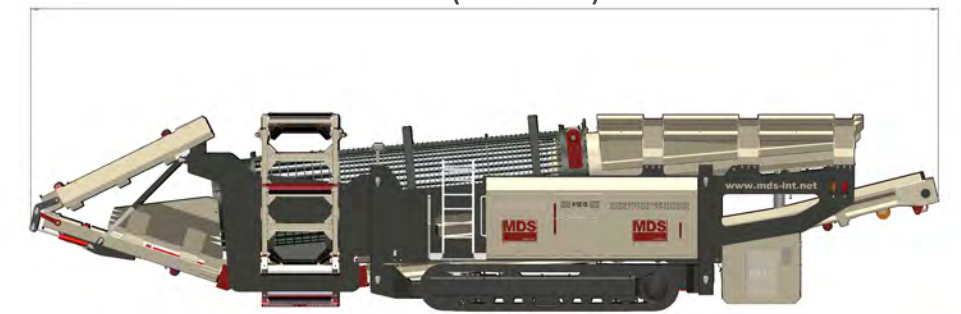

**WORKING DIMENSIONS**

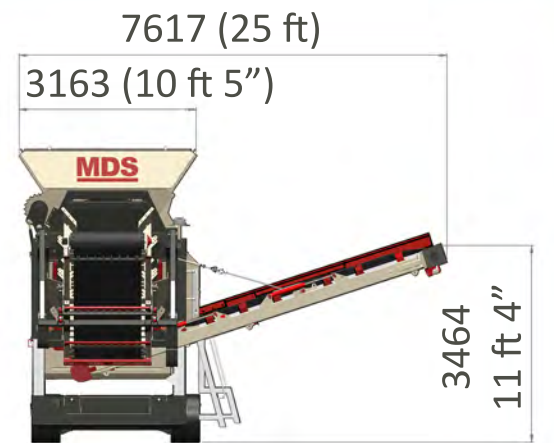

19063 (62 ft 7")

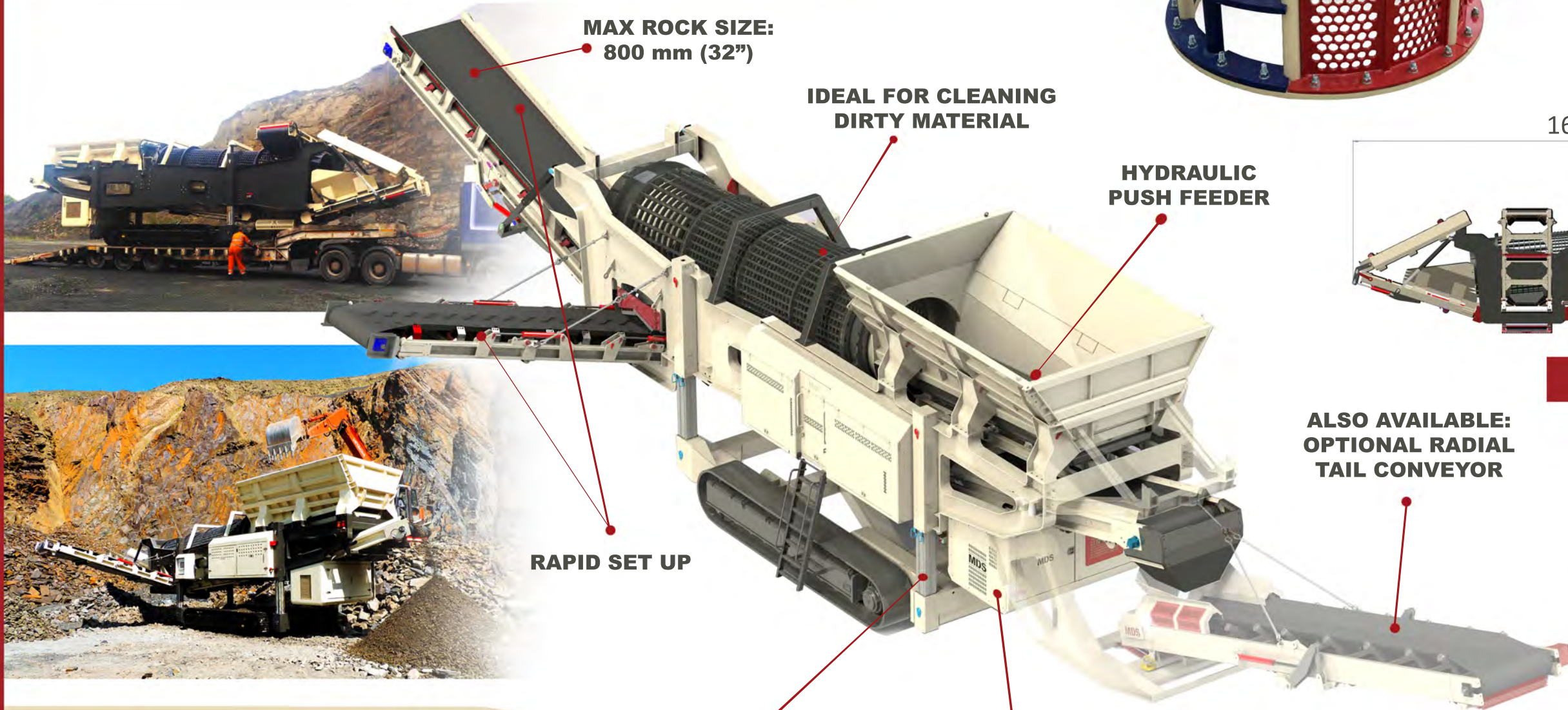
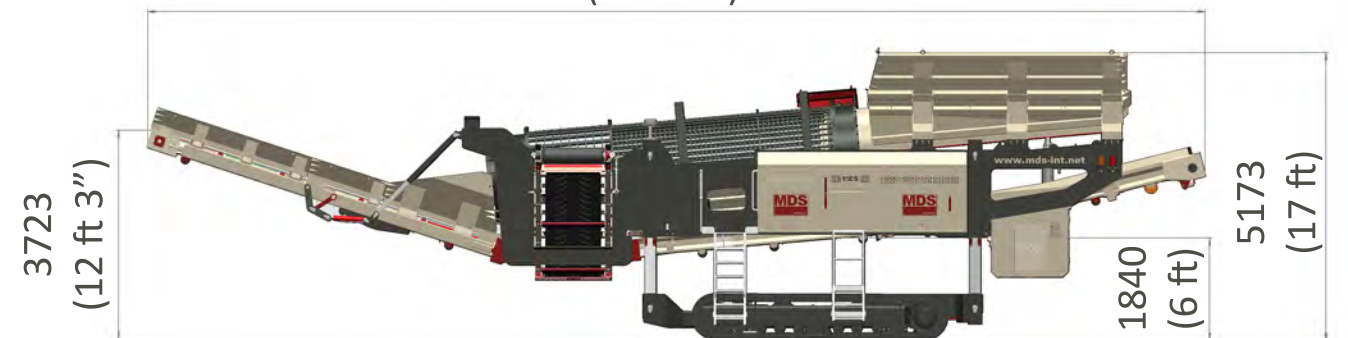

**MAX ROCK SIZE:  
800 mm (32")**

**IDEAL FOR CLEANING  
DIRTY MATERIAL**

**HYDRAULIC  
PUSH FEEDER**

**RAPID SET UP**

**ALSO AVAILABLE:  
OPTIONAL RADIAL  
TAIL CONVEYOR**







**ADJUSTABLE  
HEIGHT**

**CAT 4.4  
ENGINE**

**MACHINE SPECIFICATIONS**

<b>Weight :</b>	50 tons
<b>Approx Tons per Hour :</b>	350 to 500 tons
<b>Drum Diameter :</b>	1.5 m (4 ft 11")
<b>Drum Length :</b>	5.5 m (18 ft 1")
<b>Number of Outputs :</b>	3 off (70-120 mm (2.5"- 5"), 120-250 mm (5"- 10") + oversize)
<b>Max Rock Size :</b>	800 mm (32")
<b>Hopper Capacity :</b>	30 tons
<b>Feed Mechanisms :</b>	Hydraulic Push Feeder
<b>Engine and Controls :</b>	Cat 4.4 / Electronic Control System

# MDS TROMMEL RANGE

MODEL	Tons per Hour	Drum Diameter	Drum Length	Number of Outputs	Screen Openings	Hopper Capacity	Feed Mechanism	Engine and Controls
<b>MDS M515 TROMMEL</b>	<b>Mobile track machine for use with primary blast, dirty material or rip rap</b>							
	350 to 500 tons	1.5 m (4 ft 11")	5 m (16 ft 5")	4 off	16 mm to 250 mm (0.5" to 10")	30 tons	Hydraulic Push Feeder	Cat 4.4 / Electronic Control System
<b>MDS M615 STATIC TROMMEL</b>	<b>Semi mobile machine which can be moved from site to site and can be loaded by an excavator or dump truck</b>							
	350 to 500 tons	1.5 m (4 ft 11")	6 m (19 ft 8")	4 off	16 mm to 500 mm (0.5" to 20")	30 tons	Hydraulic Push Feeder	Cat 4.4 / Electronic Control System
<b>MDS M820 TROMMEL</b>	<b>A large heavy duty static rock trommel ideal for cleaning dirty rock or screening blasted material</b>							
	750 tons	2 m (6 ft 7")	8 m (26 ft 3")	3 or 4 off	16 mm to 500 mm (0.5" to 20")	70 tons	Hydraulic Push Feeder	CAT 6.6 / Electronic Control System
<b>MDS M825 TROMMEL</b>	<b>A super sized heavy duty static trommel for maximum output. It can be set up on concrete walls or a metal chutes structure</b>							
	1000 tons	2.5 m (8 ft 2")	8 m (26 ft 3")	3 off	70 mm to 500 mm (3" to 20")	100 tons	Hydraulic Push Feeder	Cat 6.6 / Electronic Control System
<b>MDS M520R TROMMEL</b>	<b>A static trommel ideal for compost or light recycling</b>							
	15 tons	2 m (6 ft 7")	5 m (16 ft 5")	2 off	5 mm to 50 mm (0.2" to 2")	X	X	2 off 3 kW Motors (4 HP)
<b>MDS M820R TROMMEL</b>	<b>A tough static machine built for recycling concrete and demolition or any heavy duty recycling</b>							
	50 tons	2 m (6 ft 7")	8 m (26 ft 3")	2 or 3 off	10 mm to 250 mm (0.4" to 10")	X	X	2 off 15 kW Motors (20 HP)
<b>MDS APRON FEEDERS</b>	<b>Manufactured to your requirements</b>							

**QUARRY FEEDER**



**MINING FEEDER**

