

MDS

www.mds-int.net

M412 TRACK TROMMEL

<http://www.mds-int.net>



MDS-INT
Drummond
Carrickmacross
Co. Monaghan, IRELAND

TEL: +353 42 966 7899
EMAIL: info@mds-int.net
WEB: www.mds-int.net

[f /MDSInternational](https://www.facebook.com/MDSInternational) [YouTube /MDSInternational](https://www.youtube.com/MDSInternational) [@/MDSInternational](https://www.instagram.com/MDSInternational)

The M412 Track Trommel is ideal for screening from light material all the way upto recycling demolition waste. This machine can also operate in the quarry, cleaning dirty material upto 600mm (24") in height. it comes complete with fold out stockpiling conveyors and is ideal for moving around the quarry and from one site to the next.



CHANGEABLE SCREENS

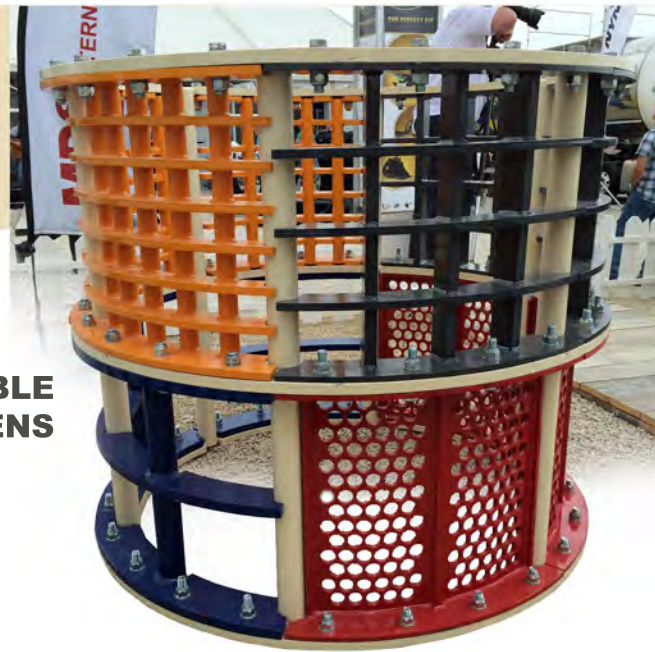

HEAVY DUTY DRUM FOR DEMOLITION RECYCLING

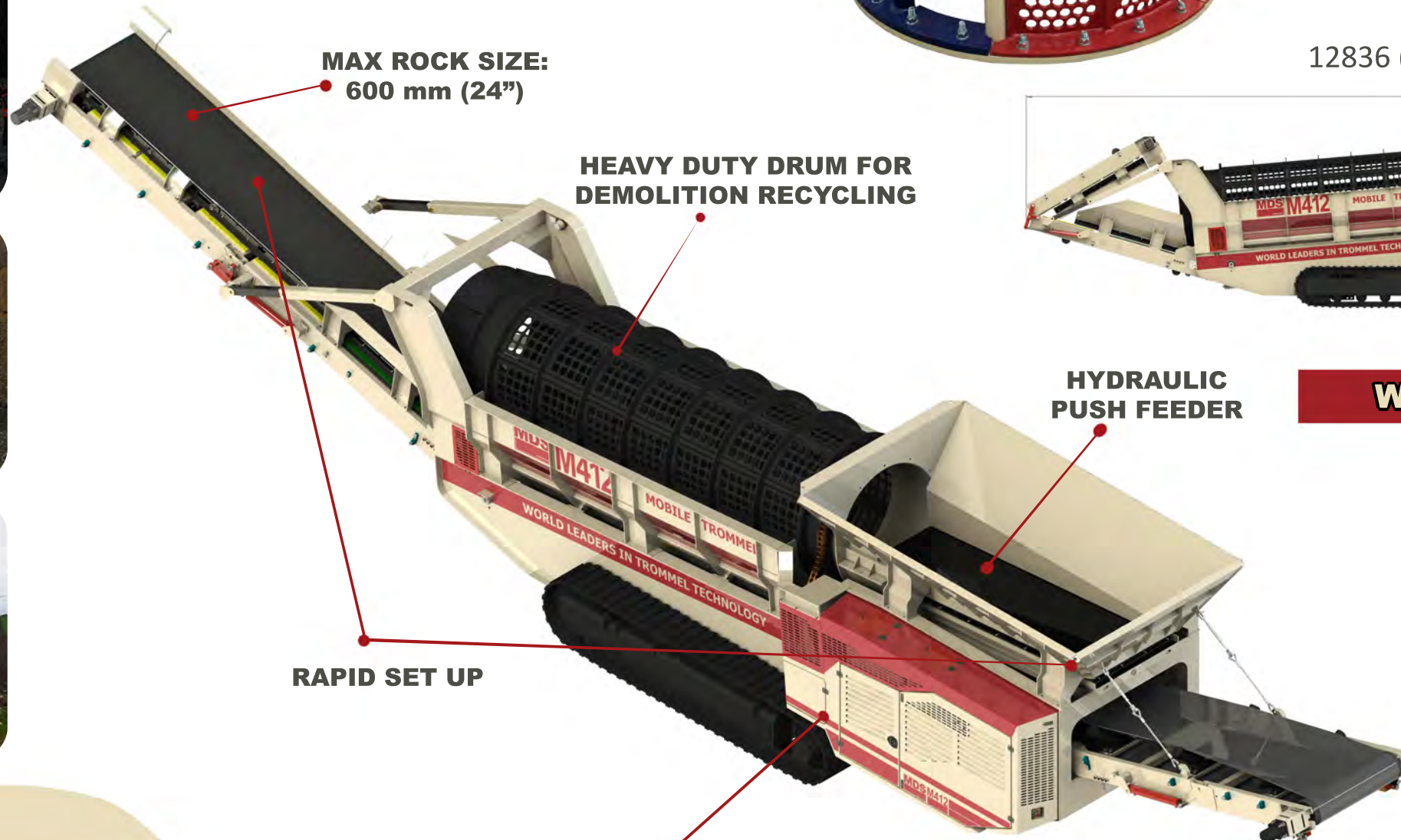

**MAX ROCK SIZE:
600 mm (24")**

**HYDRAULIC
PUSH FEEDER**

RAPID SET UP

**CAT 2.2 TIER 4
ENGINE**

TECHNICAL SPECIFICATIONS

TRANSPORT DIMENSIONS

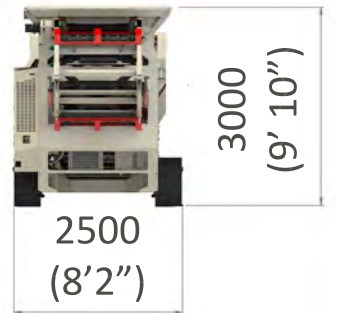

12836 (42' 1")



WORKING DIMENSIONS

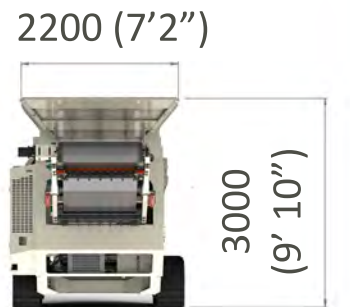



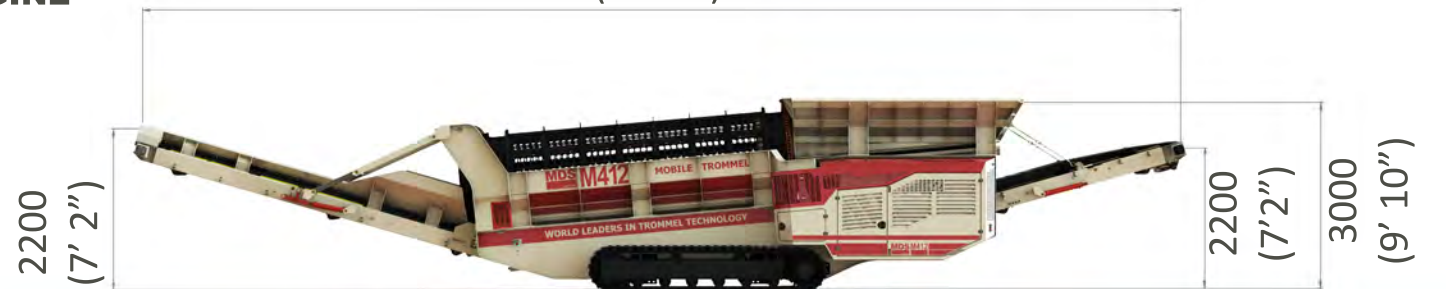



17045
(55' 7")



MACHINE SPECIFICATIONS

Weight :	21.5 tons (47 400 lbs)
Approx Tons per Hour :	200 tons
Drum Diameter :	1.25 m (4' 1")
Drum Length :	4 m (13' 1")
Number of Outputs :	2 off (up to 200 mm (8") + oversize)
Max Rock Size :	600 mm (24")
Hopper Capacity :	4 m ³
Feed Mechanisms :	Hydraulic Push Feeder
Engine and Controls :	Cat 2.2 TIER 4 / Electronic Control System

MDS TROMMEL RANGE

MODEL	Tons per Hour	Drum Diameter	Drum Length	Number of Outputs	Screen Openings	Hopper Capacity	Feed Mechanism	Engine and Controls
MDS M515 TROMMEL	Mobile track machine for use with primary blast, dirty material or rip rap							
	350 to 500 tons	1.5 m (4 ft 11")	5 m (16 ft 5")	3 off	25 mm to 460 mm (1" to 18")	30 tons	Hydraulic Push Feeder	Cat 4.4 / Electronic Control System
MDS M615 STATIC TROMMEL	Semi mobile machine which can be moved from site to site and can be loaded by an excavator or dump truck							
	350 to 500 tons	1.5 m (4 ft 11")	6 m (19 ft 8")	4 off	25 mm to 500 mm (1" to 20")	30 tons	Hydraulic Push Feeder	Cat 4.4 / Electronic Control System
MDS M820 TROMMEL	A large heavy duty static rock trommel ideal for cleaning dirty rock or screening blasted material							
	750 tons	2 m (6 ft 7")	8 m (26 ft 3")	3 or 4 off	25 mm to 600 mm (1" to 24")	70 tons	Hydraulic Push Feeder	CAT 6.6 / Electronic Control System
MDS M825 TROMMEL	A super sized heavy duty static trommel for maximum output. It can be set up on concrete walls or a metal chutes structure							
	1000 tons	2.5 m (8 ft 2")	8 m (26 ft 3")	3 off	70 mm to 600 mm (3" to 24")	100 tons	Hydraulic Push Feeder	Cat 6.6 / Electronic Control System
MDS M520R TROMMEL	A static trommel ideal for compost or light recycling							
	15 tons	2 m (6 ft 7")	5 m (16 ft 5")	2 off	5 mm to 50 mm (0.2" to 2")	X	X	2 off 3 kW Motors (4 HP)
MDS M820R TROMMEL	A tough static machine built for recycling concrete and demolition or any heavy duty recycling							
	50 tons	2 m (6 ft 7")	8 m (26 ft 3")	2 or 3 off	10 mm to 250 mm (0.4" to 10")	X	X	2 off 15 kW Motors (20 HP)

MDS APRON FEEDERS

Manufactured to your requirements

QUARRY FEEDER



MINING FEEDER

